

CZ - NÁVOD NA MONTÁŽ A ÚDRŽBU
SK - NÁVOD NA MONTÁŽ A ÚDRŽBU
HU - ÖSSZESZERELÉSI ÉS KARBANTARTÁSI ÚTMUTATÓ
PL - INSTRUKCJA MONTAŻU I KONSERWACJI



vyvýšený záhon / vyvýšený záhon
emelt virágágyás / grządka ogrodowa





KARIBU HOCHBEET 190

(73088 / 73089)

CZ - Před stavbou si přečtěte až do konce tento montážní návod
SK - Pred stavbou si prečítajte až do konca tento montážny návod
HU - A felállítás előtt olvassa el ezt az összeszerelési útmutatót az elejétől a végéig
PL - Przed rozpoczęciem budowy przeczytaj do końca niniejszą instrukcję montażu





87174 87175 87176
88496 88497

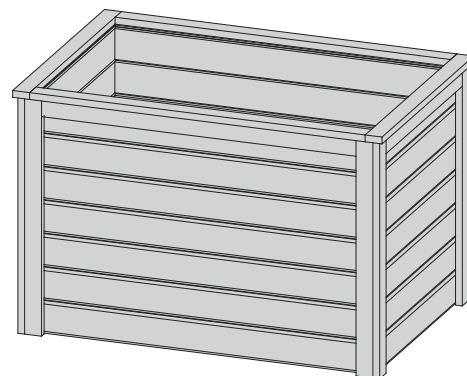









-  Vnitřní fólie je součástí produktu (nejedná se o obal)
-  Vnútrotná fólia je súčasťou produktu (nejedná sa o obal)
-  A belső fólia a termék része (nem csomagolás)
-  Folia wewnętrzna jest częścią produktu (nie jest opakowaniem)







-  **Aufbauanleitung**
-  **Building Instructions**
-  **Notice de montage**
-  **Montagehandleiding**
-  **Montagevejledning**
-  **Instrucciones de construcción**
-  **Istruzioni per il montaggio**
-  **Montážní návod**
-  **Montážny návod**
-  **Telepítési utasítások**
-  **Instrukcja montażu**

*  Nicht im Lieferumfang enthalten
 Not included
 Non comprises dans la livraison
 Niet bijgeleverd

 V ceně není zahrnuto
 V cene nie je zahrnuté
 Az ár nem tartalmazza
 Nie wliczone w cenę

1  Länge muss ermittelt und zugesägt werden
 Length must be determined and sawn
 La longueur doit être déterminée et sciée
 De lengte moet worden bepaald en worden gezaagd

 Délka musí být naměřená a uříznutá
 Dĺžka musí byť nameraná a odrezaná
 A hosszt meg kell mérni és le kell vágni
 Długość musi być zmierzona i odcięta

2  Nicht gebraucht
 Not needed
 Pas nécessaire
 Niet nodig

 Není nutná
 Nie je nutná
 Nem szükséges
 Nie jest konieczna

3  Mit Zubehör
 With accessories
 Avec accessoires
 Met toebehoren

 S příslušenstvím
 S príslušenstvom
 Kiegészítőkkal
 Z akcesoriami

4  Fixiert vorübergehend
 Fixed temporarily
 Temporairement fixe
 Tijdelijk vast

 Dočasně pevný
 Dočasne pevný
 Részben szilárd
 Częściowo solidny

 Vergleichen Sie zuerst die Material-liste mit Ihrem Paketinhalt! Bitte haben Sie Verständnis, dass Beanstandungen nur im nicht aufgebauten Zustand bearbeitet werden können!

 Vergelijk eerst de lijst van materialen met de inhoud van uw pakket! Reclamaties kunnen alleen in behandeling worden genomen zolang de onderdelen nog niet zijn gemonteerd!

 A telepítés megkezdése előtt ellenőrizze a csomag tartalmát!

 First compare the list of materials with your package contents! Please understand that complaints can be processed in the non-built status only!

 Start med at kontrollere materialelisten med indholdet af den leverede pakke! Vi gør venligst opmærksom på at reklamationer kun kan behandles for materialer som ikke er blevet bearbejdet!

 Před začátkem montáže zkontrolujte obsah balení! Montážní návod Vám pomůže s identifikací dílů.

 Pred začiatkom montáže skontrolujte obsah balenia! Montážny návod Vám pomôže s identifikáciou dielov.

 Commencez par comparer la liste du matériel avec le contenu de votre paquet! Sachez que nous traitons uniquement les réclamations concernant le matériel à l'état non monté!

 En primer lugar, compare la lista de material con el contenido del paquete. Rogamos entienda que las reclamaciones sólo pueden ser tramitadas antes de montar el objeto!

 Przed rozpoczęciem montażu sprawdź zawartość opakowania! Instrukcja montażu pomoże Ci w identyfikacji części.

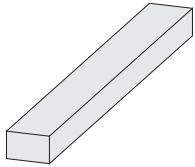
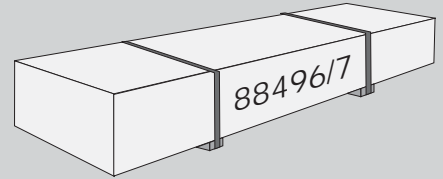
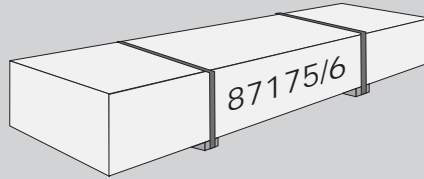
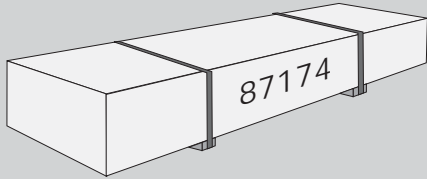

4 x B1	645 x 45 x 18 mm	ID 63865
8 x B2	624 x 45 x 18 mm	ID 87177
4 x B3	890 x 45 x 18 mm	ID 16422

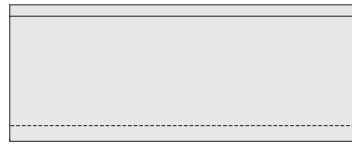

14 x R1	590 x 96 x 19 mm	ID 25597
14 x R2	890 x 96 x 19 mm	ID 34114



1 x	ID 65384
-----	----------

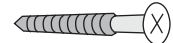

180 x	4 x 35 mm	ID 3687
40 x	4 x 50 mm	ID 3688

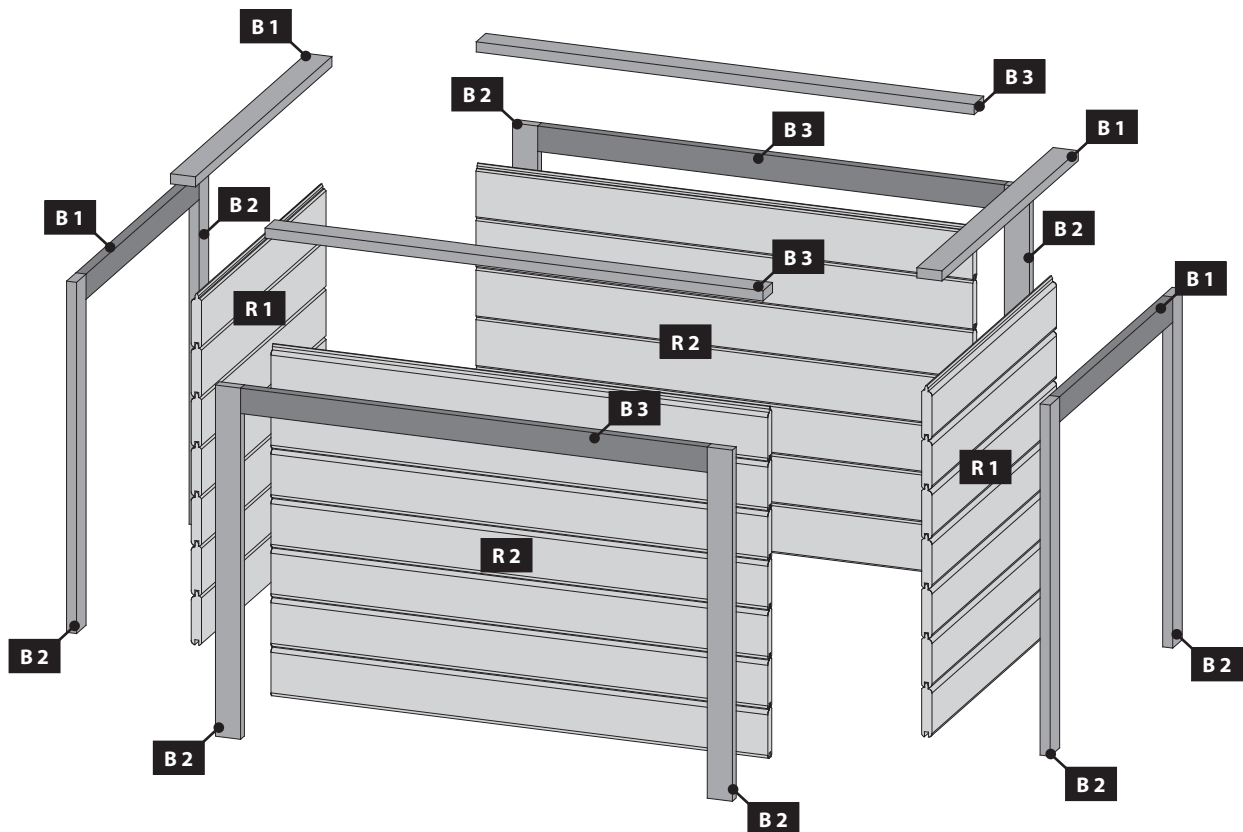

Ø3mm 4x35

112x

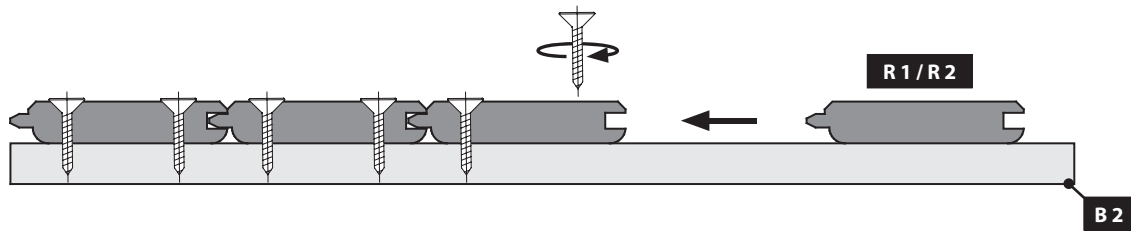

01

2x

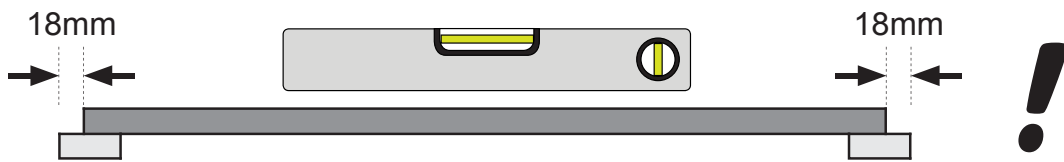
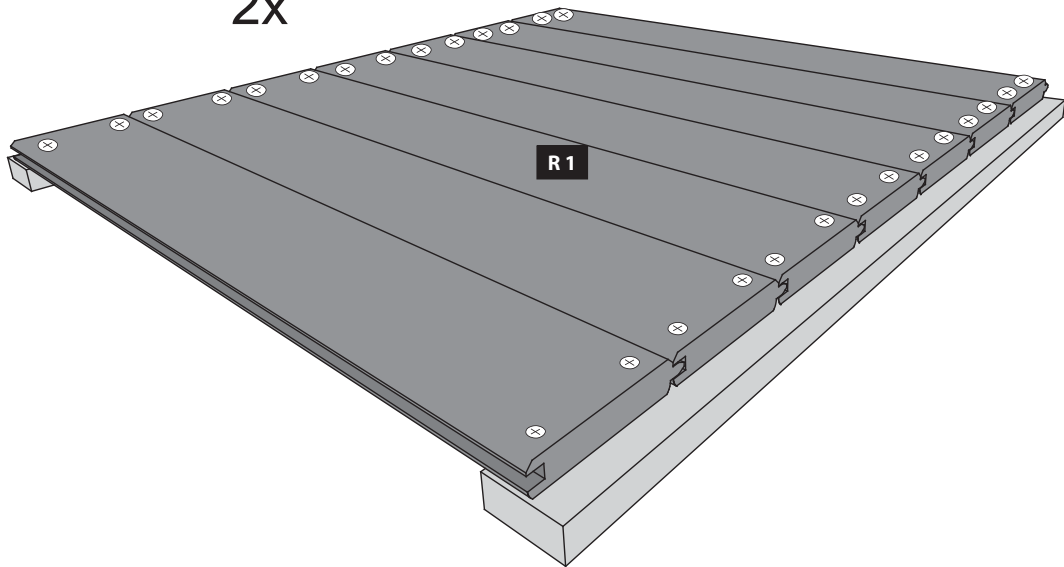

2x

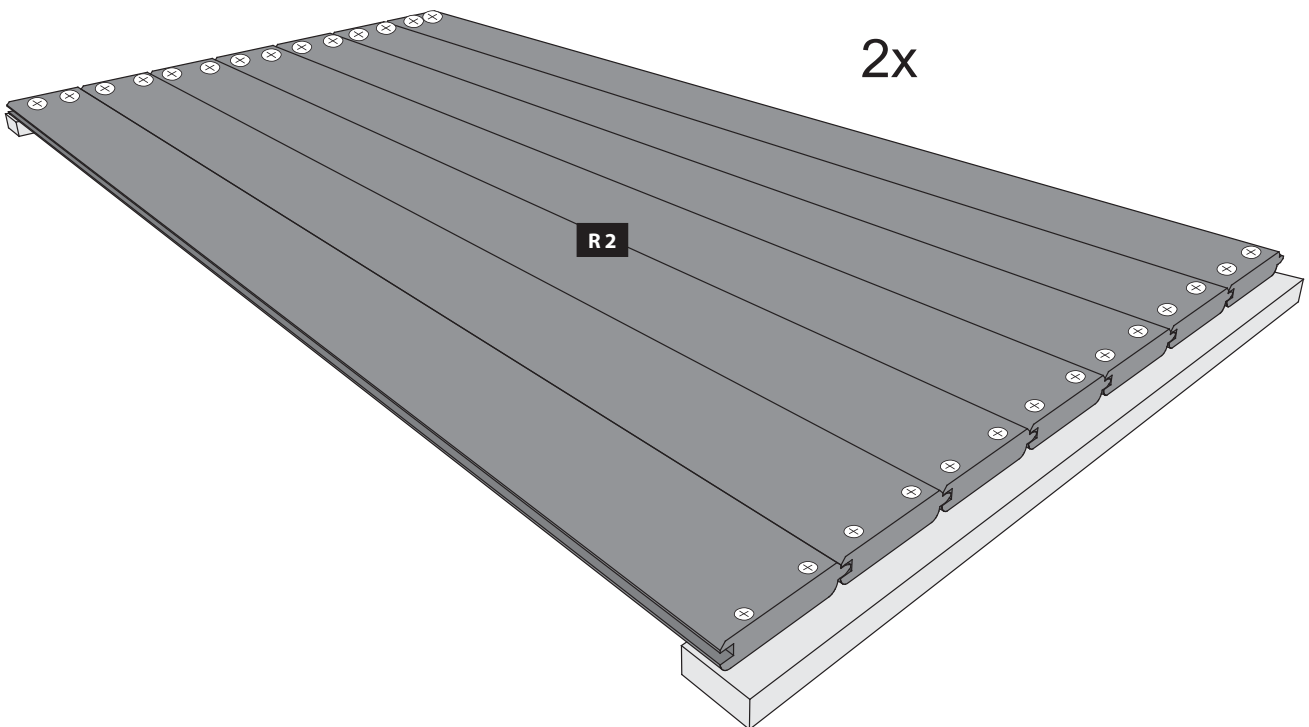

20x

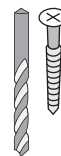

-  Bündig!
-  Flush!
-  Affleurement!
-  Gelijk!
-  Zarovnat !
-  Zarovnat!
-  Align!
-  Wyrównać!

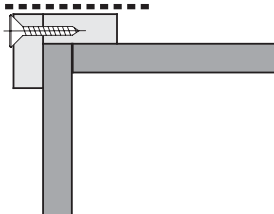

02

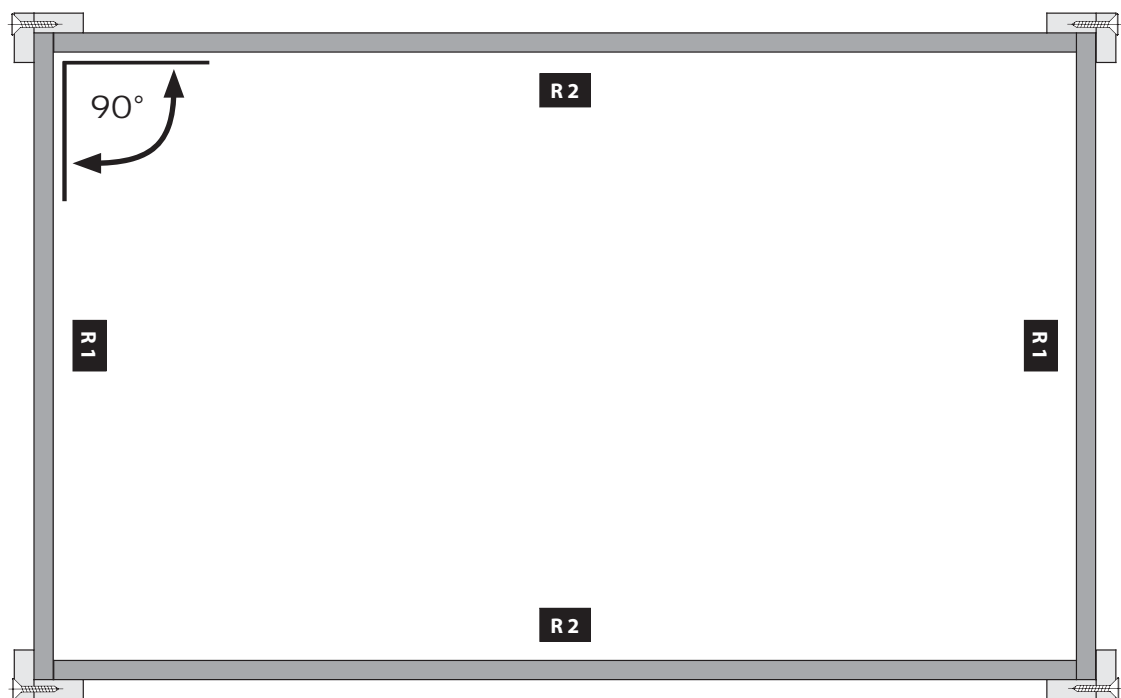
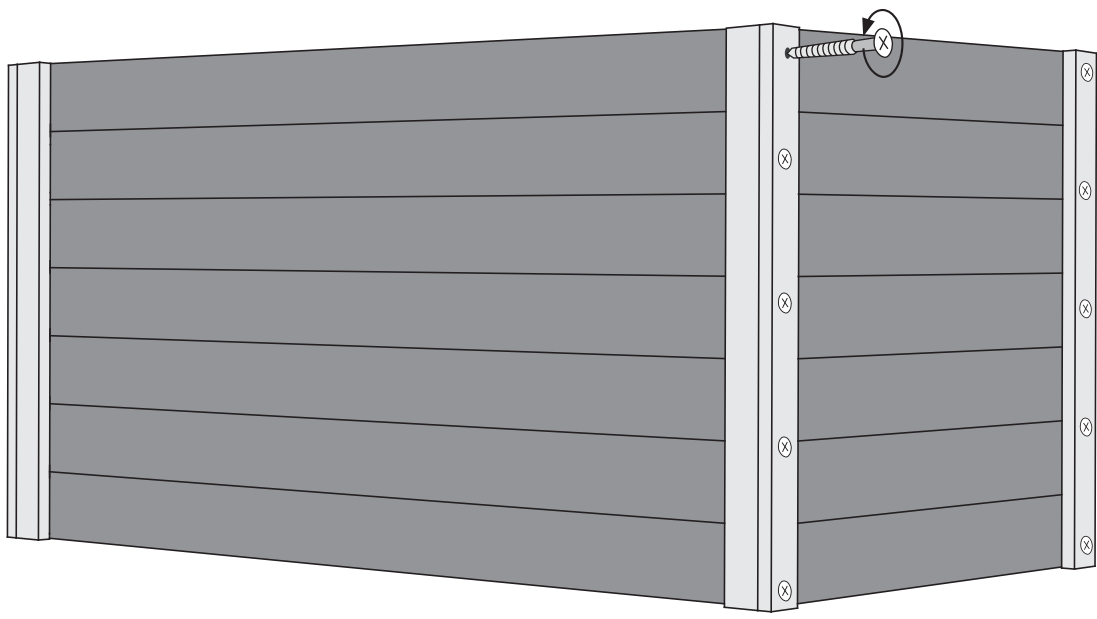

18x

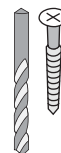

-  Bündig!
-  Flush!
-  Affleurement!
-  Gelijk!
-  Zarovnat !
-  Zarovnat!
-  Align!
-  Wyrównać!

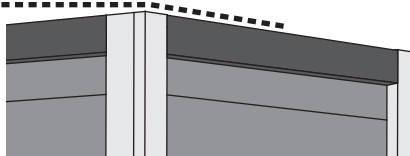

03

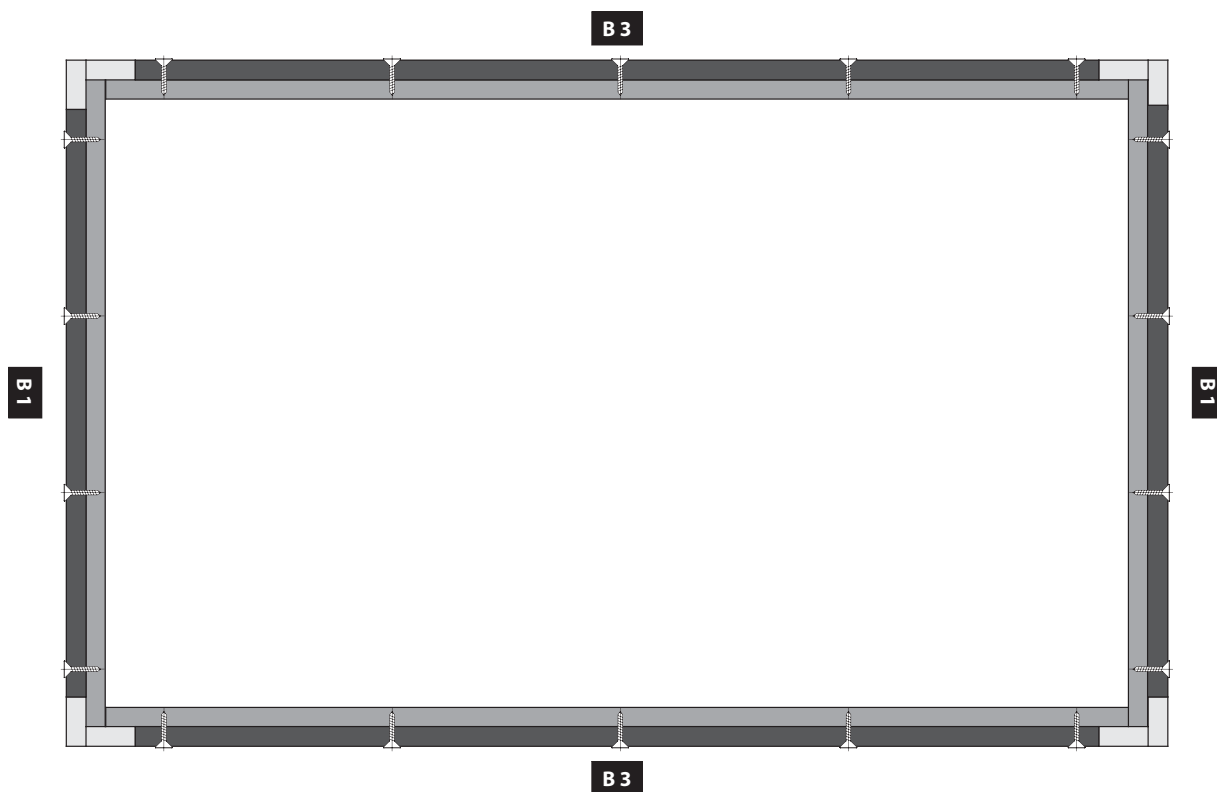
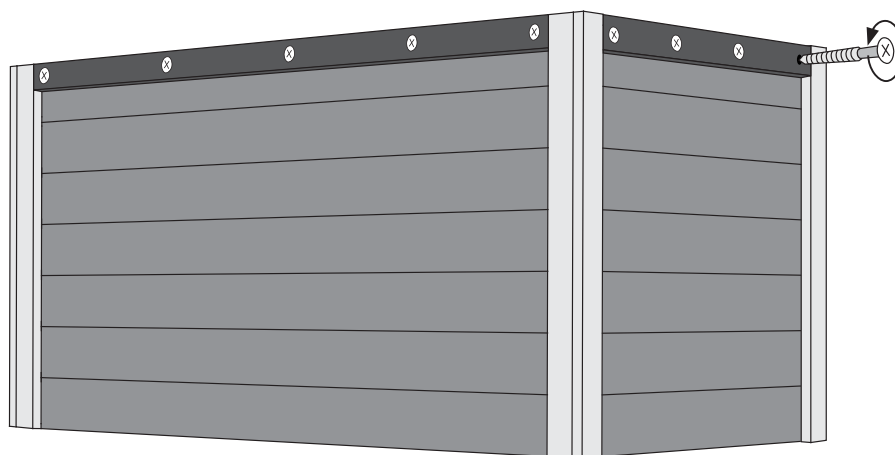
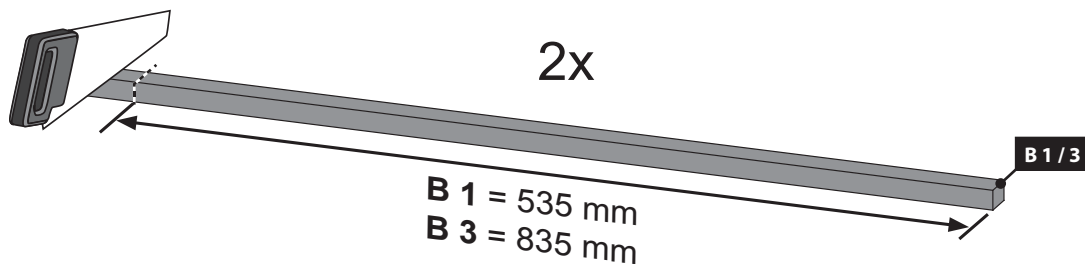

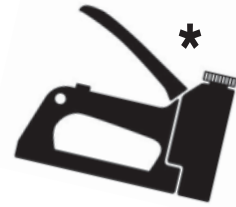
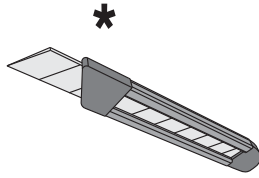

04

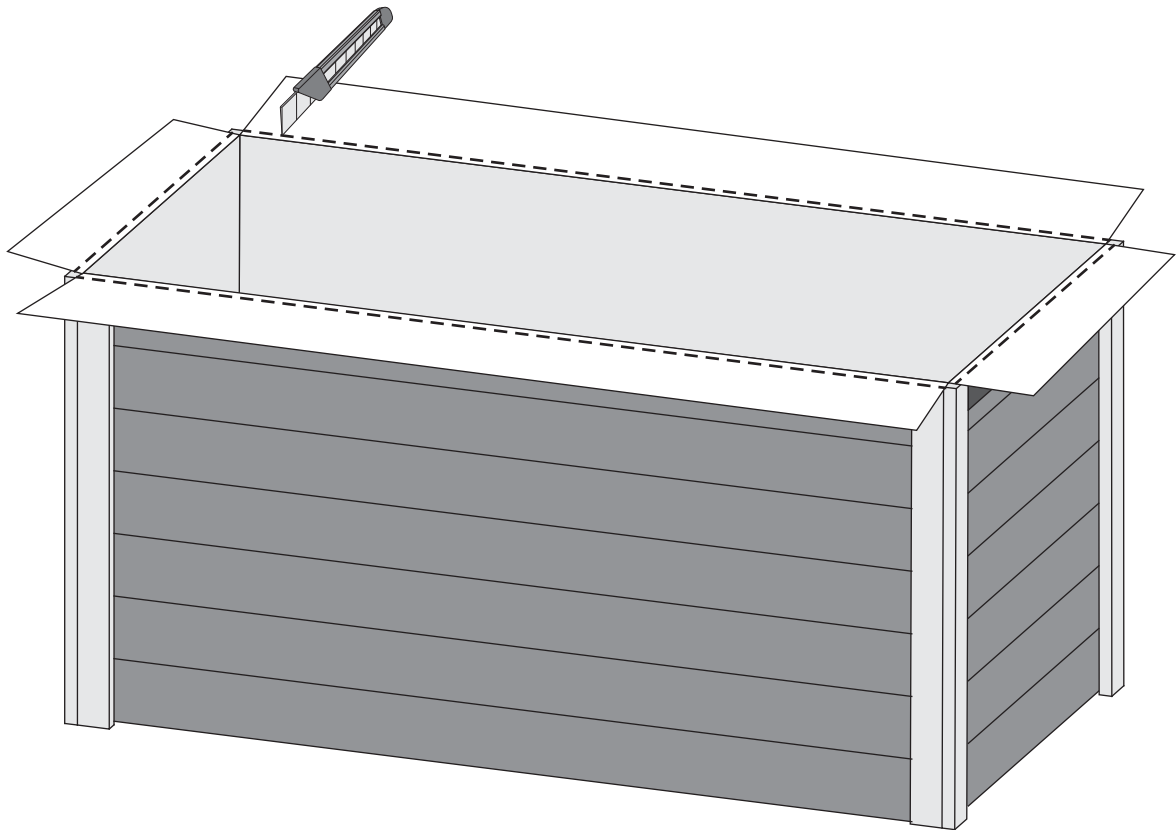

18x

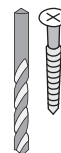

-  Bündig!
-  Flush!
-  Affleurement!
-  Gelijk!
-  Zarovnat !
-  Zarovnat!
-  Zarovnat!
-  Zarovnat!
-  Zarovnat!
-  Zarovnat!
-  Zarovnat!
-  Zarovnat!
-  Zarovnat!
-  Zarovnat!
-  Zarovnat!
-  Zarovnat!
-  Zarovnat!
-  Zarovnat!
-  Zarovnat!
-  Zarovnat!
-  Zarovnat!
-  Zarovnat!
-  Zarovnat!
-  Zarovnat!
-  Zarovnat!
-  Zarovnat!
-  Zarovnat!
-  Zarovnat!
-  Zarovnat!
-  Zarovnat!
-  Zarovnat!
-  Zarovnat!
-  Zarovnat!
-  Zarovnat!
-  Zarovnat!
-  Zarovnat!
-  Zarovnat!
-  Zarovnat!
-  Zarovnat!
-  Zarovnat!
-  Zarovnat!
-  Zarovnat!
-  Zarovnat!
-  Zarovnat!
-  Zarovnat!
-  Zarovnat!
-  Zarovnat!
-  Zarovnat!
-  Zarovnat!
-  Zarovnat!
-  Zarovnat!
-  Zarovnat!
-  Zarovnat!
-  Zarovnat!
-  Zarovnat!
-  Zarovnat!
-  Zarovnat!
-  Zarovnat!
-  Zarovnat!
-  Zarovnat!
-  Zarovnat!
-  Zarovnat!
-  Zarovnat!

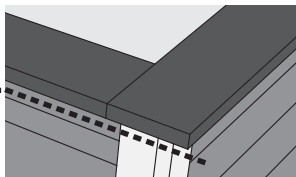

05

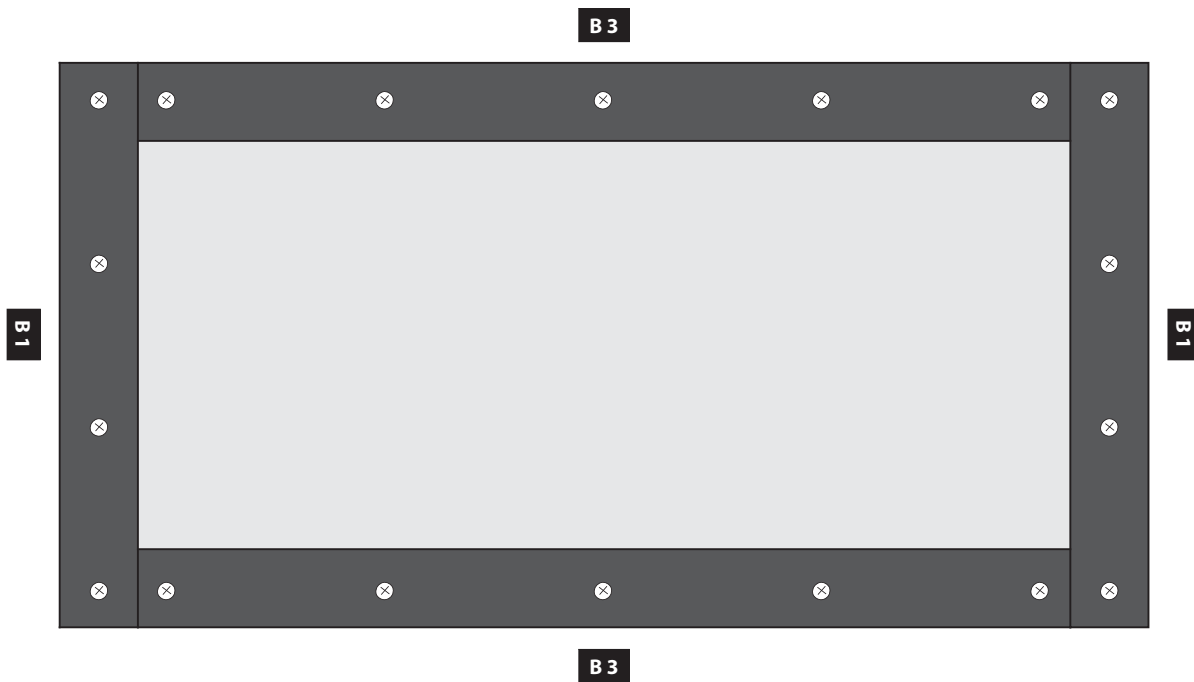
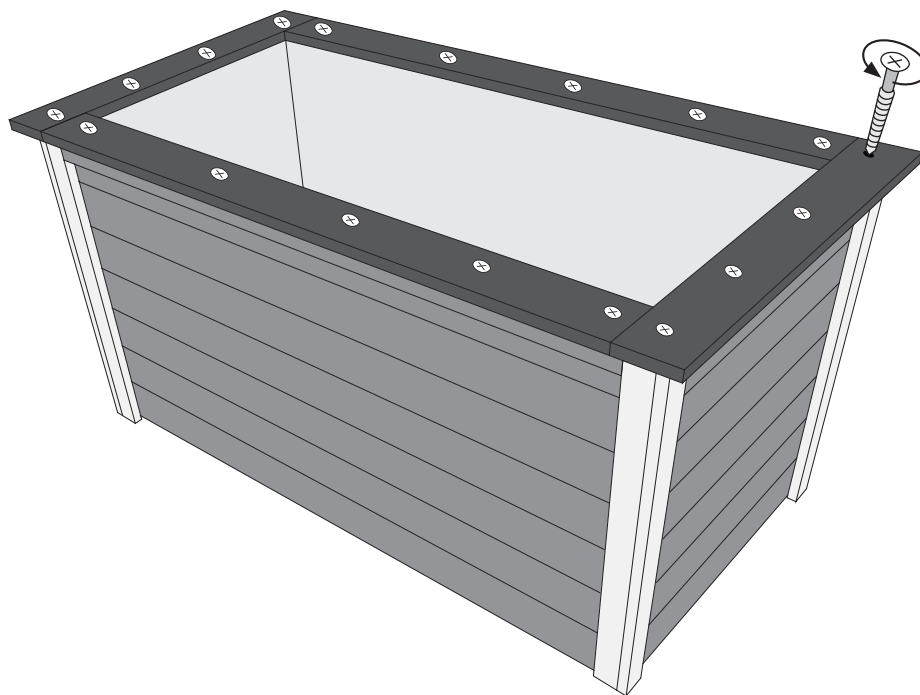

-  Hochbeet befüllen
-  fill properly
-  remplir correctement
-  goed invullen

-  vyplňte správně
-  vyplňte správne
-  helyesen töltse ki
-  wypełnij poprawnie

A

B

C

D

-  Zahradní půda
-  Záhradná pôda
-  Kerti talaj
-  Ziemia ogrodowa

-  Listí
-  Lístie
-  Kerti levelek
-  Liście

-  Malé větve
-  Malé vetvy
-  Kis ágak
-  Małe gałęzie

-  Velké větve
-  Veľké vetvy
-  Nagy ágak
-  Duże gałęzie

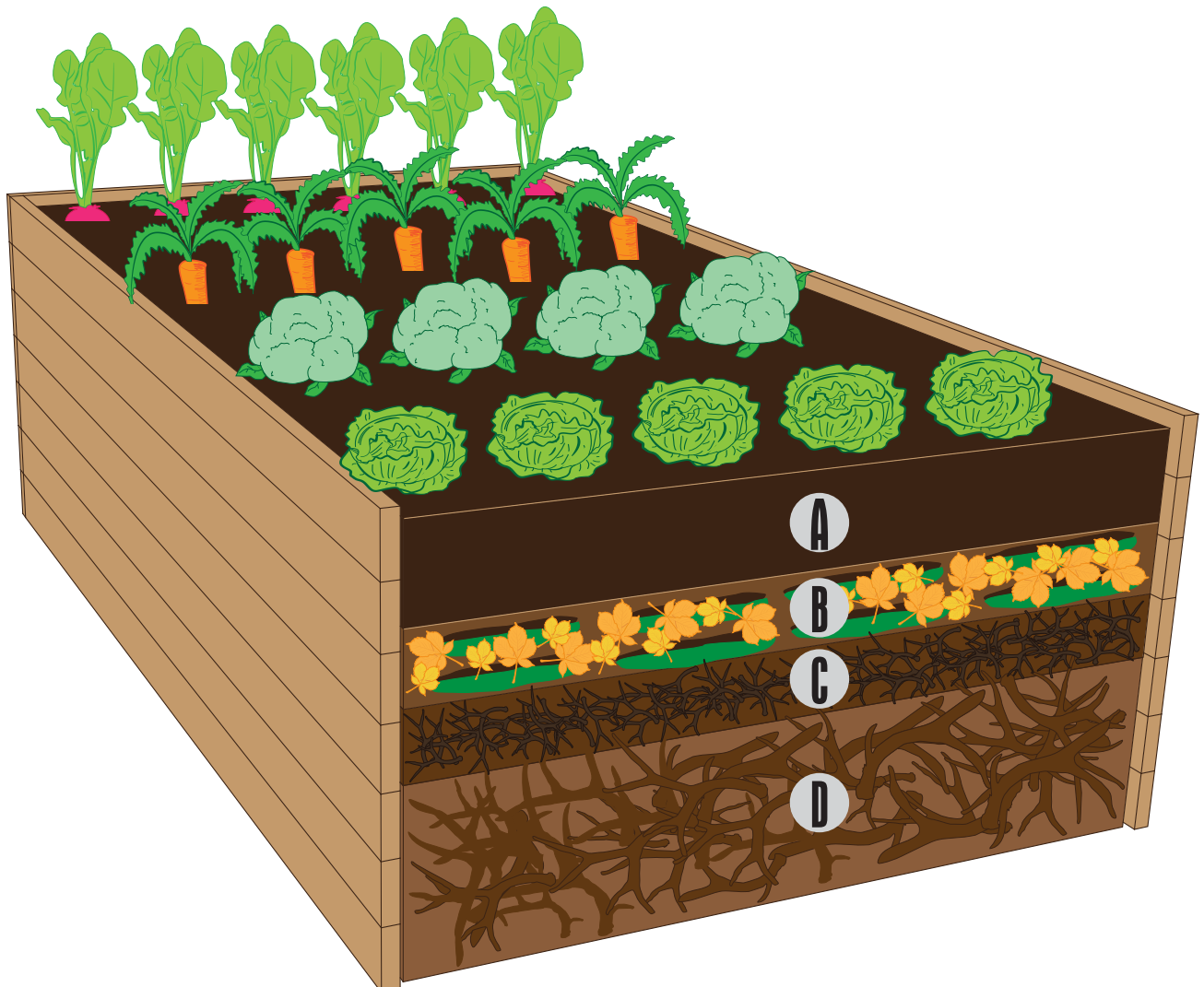

**Váš dodavatel / Váš dodávateľ
Az Ön beszállítója / Twój dostawca**



www.lanitgarden.cz

*V případě naléhavých dotazů se obraťte
na naši technickou podporu*

*V prípade naliehavých otázok sa obráťte
na našu technickú podporu*

*Sürgős kérdések esetén kérjük,
forduljon műszaki támogatásunkhoz*

*W przypadku pilnych pytań prosimy o
kontakt z naszym wsparciem
technicznym*

technik@lanitplast.cz